

Harvia Sauna

- Saunas • Bathroom saunas
- Infrared cabins • Products for steam rooms

HARVIA

Natural well-being.





Contents

Claro sauna	5
Solide	7
Rubic sauna	9
Rondium sauna	11
Variant sauna	13
Bathroom saunas	15
SmartFold bathroom sauna	17
Sirius bathroom sauna	18
Capella bathroom sauna	19
Infrared cabins	21
Unique solutions for special saunas	23
Outdoor sauna	25
Sauna interiors	26
Harmonise the look of your sauna with Harvia glass products	28
Harvia's panelling and bench material options	30
Sauna heaters	32
Add to the atmosphere of your sauna with lighting	35
Details in sauna	36
Floor plans	38

Harvia provides you with the freedom and high-quality products to make your sauna a unique and beautiful oasis of good feeling.



Harvia products are designed and manufactured with the environment in mind. Sustainable choices are not only good for the environment, they are also good for people. The Harvia Cares symbol demonstrates that Harvia is committed to sustainable development.

The material of this brochure has also been selected with respect for nature.





The relaxing elements of nature.

Harvia is more than just a sauna. With more than 60 years of experience in developing the best Finnish sauna products, Harvia knows what makes a truly enjoyable sauna bath. Harvia sauna combines the relaxing elements of nature – wood, stone and water – to bring you to an oasis of good feeling. The sauna is a beauty treatment, a moment to pamper yourself, to relax after a run or a hard day. A Harvia sauna is an aesthetic pleasure, an experience for your senses. You can easily find the perfect sauna products for you from Harvia's extensive range. Harvia sauna will exceed your every expectation.

In addition to the traditional sauna, Harvia's product range includes relaxing infrared cabins and high-quality steam room products. The soft warmth of Harvia products offers you health benefits: improved blood circulation and immunity, relief from muscle pain, stress relief, and physical and mental relaxation.

Your sauna – an oasis of good feeling.

Harvia saunas are comprehensive solutions. You get Harvia's high-quality products, aesthetic design and easy assembly – all in the same package, from the same supplier. Create your own unique sauna experience with Harvia.

Harvia – everything you need for your sauna.

Harvia's comprehensive collection comprises everything from high-quality standard products to exquisite special products. Harvia design takes modern human needs as well as the demands of heat and moisture in a sauna into careful consideration. You can choose from Claro, Solide, Rubik, Rondium and Variant indoor saunas and one of our seven alternative sauna interiors. Furnish your sauna exactly as you like it, with sauna heaters, lights, glass doors, windows, benches, panels, decorative stone walls and other Harvia products. Harvia provides you with the freedom and high-quality products to make your sauna a unique and beautiful oasis of good feeling.

A modern bathroom sauna is an ideal solution for small bathroom. A wide variety of materials and equipment allows you to create your own special style, just the way you want it.

If you want to enjoy a genuine Finnish sauna in its more traditional form, you should choose a Harvia Outdoor sauna. Experience the enjoyment of a sauna in your garden or next to your swimming pool. Many unforgettable moments are guaranteed.



Claro sauna

Clarify your thoughts.

The large transparent glass front of the Harvia Claro gives the sauna a spacious feeling. The outer wall surface is black painted wood board, which creates a beautiful contrast against the light wooden corners.

On the inside, the well-thought balance between light and dark continues in unison with the outer surface. Black spacing between the rectangular panel sheets gives the sauna interior a solid rhythm. The unique Harvia Ventura benches make use of the same design language, adding a bench that is very pleasant to sit on.

Light is one of the key concepts in the Claro sauna. Light comes in through the glass front – and when needed, the corner lamps and a LED strip in the upper bench give their warm-toned support.

Harvia Kivi heater is well suited to the nature of the sauna – the heater produces a traditional soft sauna bath in a modern way. The triangular steel frame with nearly 100 kg of sauna stones looks impressive through the glass front. Also the stylish Harvia sauna accessories set of stainless steel is included in the delivery.



S2121LS

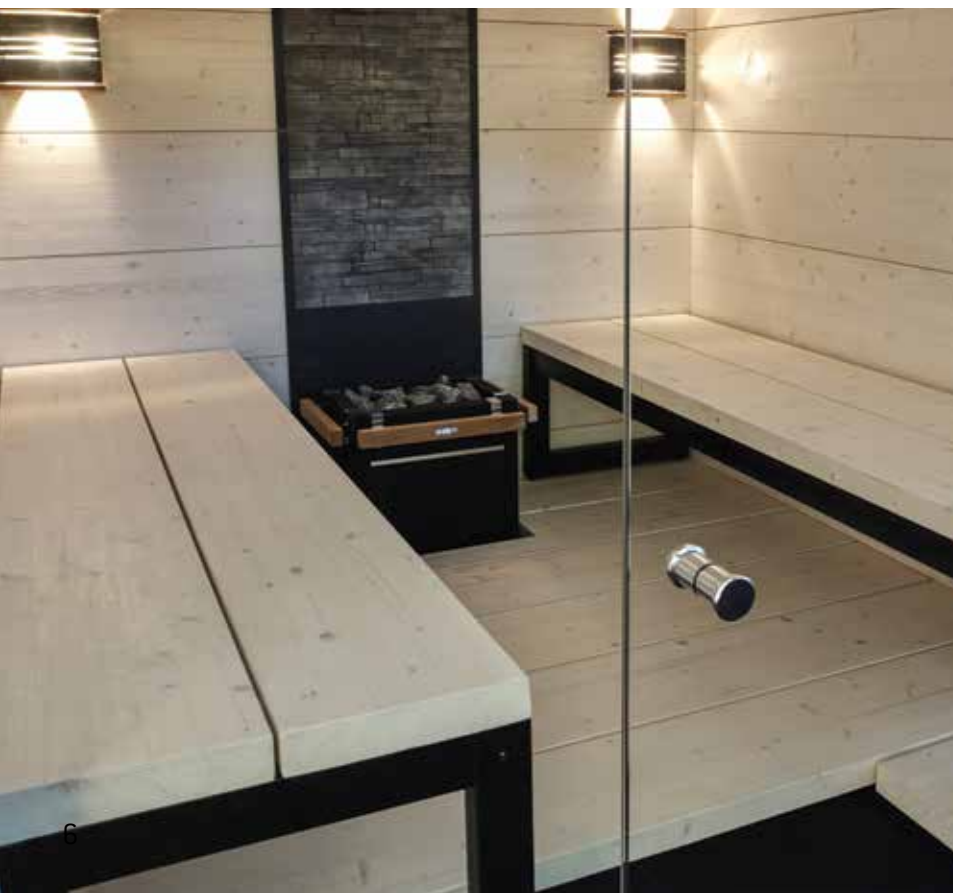

Solide

For those who appreciate design.

The Harvia Solide design sauna combines age-old sauna traditions with a fresh and modern design. Featuring a rich combination of pale and black colours, the Harvia Solide design sauna is the perfect fit for new homes. The benches are made from high-quality and moisture resistant GLT (glue-laminated timber) spruce. The surfaces can be treated with tinted sauna finish or wax or left untreated to emphasise their pale spruce colour. The bench options include a continuous bench and single sauna seats that are easy to move. The benches are tailored to the dimensions of the sauna.

The indoor sauna installation package includes wall and ceiling beams with finished wood surfaces, windows, glass doors, a Harvia Virta electric heater and lighting.



S2119LD



Rubic sauna

A message from the future.

The Harvia Rubic sauna unites metal, wood and glass creating a harmonious whole. The sturdy metal profiles in the corners give the cubical sauna integrity. There are rectangular panel sheets above the black wood board of the side and back walls. Choose the material of the panel sheets and the interior panelling from aspen, alder, or heat-treated aspen.

Glass is used in the front wall. Grates that express the style of the interior have been installed in front of the glass. The steel-covered base frame and the adjustable legs protect the walls and structures of the sauna from the humidity on the floor.

The alliance of the materials is continued on the interior as well. The stainless steel strips have been embedded into the edges of the Harvia Futura benches. The same line is continued on the light fittings and heater guard. The interior features modern slim battening. Select the material for your Futura sauna interior from aspen, abachi, alder or heat-treated aspen.

A Topclass Combi heater in your Harvia Rubic sauna provides a steamy and moist sauna bathing experience. The heater is controlled by a digital Xenio Combi control unit, which allows you to control the temperature, humidity, and lighting of your sauna. The control unit is stylishly embedded in the metal corner profile. A Harvia decorative stone wall has been mounted behind the heater. Also the stylish Harvia sauna accessories set of stainless steel is included in the delivery.



S2121RC



S2123RC





Rondium sauna

One of a kind.

Harvia's Rondium sauna is the perfect choice for bathers who want to pamper themselves. A rounded double door and decorative external stainless steel soffit with LED lights completes this stylish sauna model. Decorative stainless steel elements in the outside walls create a modern look. Even the base frame is steel-covered. This gives a stylish, modern appearance and provides protection from moisture close to the floor. Heat-treated aspen, aspen or alder is used for the exterior panelling. Aspen is used on the interior walls and ceiling.

The tasteful Exclusive sauna interior, with detachable benches, is made of abachi and heat-treated aspen. The decorative stone wall gives this sauna a stylish contrast. The Topclass Combi is a versatile heater especially for those who enjoy a soft, humid sauna bath with an aromatic atmosphere. The heater is controlled by a digital Griffin Combi control unit, which allows you to control the temperature, humidity, and lighting of your sauna.

Harvia colour light brings the magnificence of colours into your sauna. It is controlled by Griffin Colour Light control unit.



S2222KL



Variant sauna

Create your own oasis.

The basic layout of the Harvia Variant sauna is ample and provides you with the opportunity for a variety of different arrangements. The Variant sauna is also the most flexible of Harvia's sauna designs: you have five options (spruce, pine, aspen, alder and heat-treated aspen) for wall and ceiling panelling, and you can choose the windows and the tone of the doors that best match your personal taste.

You can choose the interior design of your Variant sauna from Harvia's five stylish alternatives (p. 26–27). A Variant sauna is completely insulated and, therefore, very energy efficient. Metallic corner pieces on the corners of the fascia board give your sauna a distinctive look.

The Harvia Variant sauna represents the modern Finnish sauna at its best. The benches, as well as the sauna interior, are designed ergonomically and following original Finnish sauna traditions.

The benches, headrests and backrests are made from easy-care abachi wood as standard. High-quality bench design and soft sauna lighting guarantee your enjoyment.



S2222R



S2522M



S2020





Bathroom saunas

An ideal solution for a small space.

Harvia offers a complete new range of high quality saunas. Harvia bathroom saunas are designed especially for bathroom's scarce space and humid conditions. The wall elements are of water, humidity and thermal insulated material. The waterproof sidewall of the sauna can also be used as a shower wall.

Bathroom sauna can be installed almost anywhere, in apartments, hotels, ships etc. Bathroom sauna is well-suited as a renovation product but it fits in new constructions as well. Assembly of a bathroom sauna is a matter of hours.

Select your favourite from Sirius, Capella or SmartFold models and pick the size which suits your purposes best. It is also possible to manufacture a tailor-made bathroom sauna according to your needs and wishes. Please contact your local dealer.



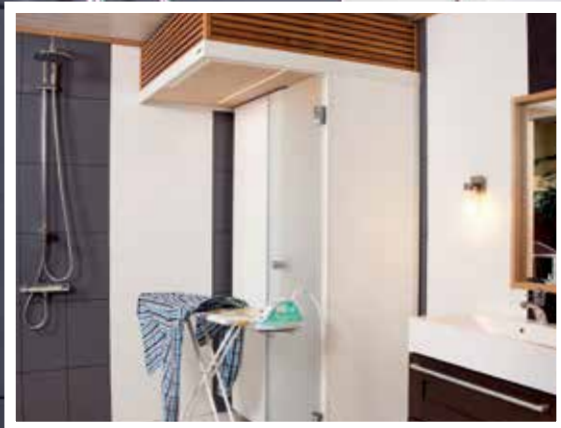

SmartFold bathroom sauna

This is the beginning of a new era of space utilization. Harvia's new foldable and adaptable bathroom sauna SmartFold only uses floor space when it is needed. SmartFold is a real lifecycle sauna, suitable for all users during various stages of life.

Compared to a traditional sauna solution, you save up to several square meters of space. Harvia SmartFold allows you to use the bathroom as an efficient utility room. When one half of the floor space required by the sauna can be utilized for other purposes, you will have a nice amount of additional space for a drying rack, iron, or for changing the soil in your potted plants, for example.

The saved space makes the everyday life of a young family easier, and the solution also pays attention to accessibility and older users. When the benches are left folded up, the sauna can be accessed with a wheelchair, and if climbing to sit on the benches of a regular sauna is difficult for you, you can leave the upper bench of the SmartFold sauna folded up, and enjoy the heat while sitting on the lower bench.



SC1212



Sirius bathroom sauna

Harvia Sirius is a stylish and modern bathroom sauna model with plenty of glass surface at front. The width of the bench is over 100 cm in each model, so there is room for two persons to relax and enjoy the sauna bath of Harvia Vega Compact heater.

In the standard delivery the Formula sauna interior and panelling are of alder. The Formula sauna interior is available also in aspen. Also Futura sauna interior model can be selected, the wood material options are aspen, alder and heat-treated aspen. Instead of the standard alder panelling, you can select aspen or heat-treated aspen.

The stylish Harvia sauna accessories set of stainless steel is included in the delivery. Tall, modern door handle gives the finishing touch for Sirius model.

Options available: fibre optic lights, upper covering ribs and side cover.



SC1412



SC1111K



Capella bathroom sauna

The Harvia Capella bathroom sauna for two is an ideal solution for a small bathroom, adding a touch of luxury while taking up no more space than a standard bathtub. It can be built even in a space no bigger than 145 x 90 cm.

Capella bathroom sauna's benches, stool and panelling are of alder.

Capella is equipped with space saving sliding doors, giving the sauna a modern appearance and bringing a feeling of space to the bathroom. The stylish Harvia sauna accessories set of stainless steel is included in the delivery.

Options available: floor basin (for models SC1409 and SC1409D), fibre optic lights, upper covering ribs and side cover.



SC1409



RONDUM SG1515KL



RADIANT SGC0909BR



RADIANT SGC1210BR



Infrared cabins

Relax whenever it suits you.

An infrared cabin lets you relax in warmth whenever it best suits you. The warmth of the infrared cabin comes from heat radiator elements which produce dry, long-wave heat. The healthy warmth is similar to that produced by the sun. The infrared radiation provides you with an all-encompassing feeling of relaxation.

Infrared warmth also offers you several health benefits: improved blood circulation and immunity, relief from muscle pain, stress relief, and physical and mental relaxation. An infrared cabin can be installed in any dry space, for example in your bedroom.

Rondium infrared cabin

The Rondium infrared cabin is in a class of its own when it comes to finish and detail. The different wood materials, combined with metal, give the cabin a unique and distinguished look. The decorative external stainless steel soffit is equipped with three LED lights. Even the base frame is steel-covered, which gives a stylish, modern appearance.

Light-coloured aspen is used on the interior walls and ceiling. The benches are made from aspen and heat-treated aspen. Heat-treated aspen, aspen or alder is used for the exterior panelling.

The rounded glass corner with double door is made without a threshold, so it's easily accessible even by wheelchair. There are three sizes of Rondium infrared cabin to choose from. The Harvia Griffin Infra control unit is used to control the Rondium infrared cabin.

Radiant infrared cabin

The Radiant infrared cabins have a modern design and plenty of glass surfaces. The large heating elements are positioned so that the long-wave heat can reach all parts of your body.

You can set the operating time and temperature of the Radiant infrared cabin with the easy-to-use control panel. You can even listen to your favourite music on the cabin's built-in radio/CD player.

Radiant infrared cabin's interior is made of hemlock wood, a pleasant-scented, light-coloured wood related to pine. The outer surface is dark walnut veneer. Choose from two different-sized models.





Unique solutions for special saunas

Harvia also provides custom-made sauna interiors for large spaces, with individual benches and paneling designed based on your drawings or requests. The design and quality of Harvia's custom-made saunas is backed up by the company's extensive expertise and latest sauna technology.

Special saunas can be fitted with vertically boarded benches made from abachi, alder, aspen, fuma or heat-treated aspen, with backrests and bench surrounds made from the same material.

With a range of depth options from 400 to 1000 mm, the benches are tailored based on the dimensions of your sauna.

Infrared cabin

An infrared cabin works on the basis of direct heat radiator elements that produce infrared radiation. The infrared heat is the same kind of good warmth produced by the sun, providing you with an all-encompassing feeling of relaxation and refreshment. Enjoy the warmth of the south in your own home.

Harvia Spa Modules

Structural modules for large spas – or for your own personal spa oasis

Harvia Spa Modules offer an easy and effective way to implement the furnishings and structures of even the most demanding spa destinations. A typical solution includes the walls, ceiling and benches for a steam room, which, thanks to the unique manufacturing process, can be customised to almost any shape imaginable. The manufacturing method can also be scaled down for smaller designs, such as bathroom shower recesses.

Ready-made – just add a surface!

Harvia Spa Modules deliveries comprise wall, ceiling and seat structures as ready-to-install modules. After the modules have been installed, they are levelled and waterproofed. All the client has to do is select and purchase tiles and arrange for their installation.

Harvia Spa Modules are

- easy and quick to install and modify
- lightweight yet strong
- particularly effective at water insulation
- comfortable
(they warm up/cool down when in contact with the body much faster than concrete structures)
- made from extruded XPS polystyrene
- ecological compared to concrete (manufacturing consumes less water and energy)

For use in spas, home spas, swimming halls, gyms, hotels...

- steam rooms
- shower rooms
- cold rooms
- poolside benches, swimming pools
- furniture, such as recliners

A complete package from Harvia

- Harvia Spa Modules structures
- Harvia HGX and HGP steam generators and accessories
- Aluminium door profiles
- Lighting products
- Steam fountains





Outdoor sauna

Enjoy nature.

Harvia sauna – genuine Finnish sauna enjoyment. The feeling of the open air on your skin. A combination you have to experience! For centuries in Finland, the sauna was a separate building with its own unique features.

Now you can experience the same atmosphere with Harvia Outdoor sauna models: Solide Outdoor, Kuikka and Keitele.

Whether you choose a traditional woodburning sauna stove or an easier electric sauna heater, you will find the same distinguished Harvia sauna spirit in your Outdoor sauna.

The Harvia Outdoor sauna package delivery is much more than just the sauna building itself! The delivery package includes all the necessary wood, roof and fastening materials and, according to your choice, a woodburning sauna stove with steel chimney or an electric sauna heater.

Whether next to your swimming pool, in your green garden or in the middle of a humming forest, a Harvia Outdoor sauna offers you authentic, peaceful moments of enjoyment.



KUIKKA



KEITELE



SOLIDE OUTDOR 1



SOLIDE OUTDOR 2



SOLIDE OUTDOR 3



Sauna interiors

Furnish your sauna according to your own taste.

When you buy a Harvia Variant sauna, you select the wood material for the walls and ceiling and the sauna interior of your choice. Harvia's sauna interior packages include benches, backrests and other elements to complete your sauna. You can also furnish your sauna with separately-selected Harvia glass doors and colour lights to enhance the atmosphere. You can choose from six interior alternatives: Ventura, Solide, Scala, Futura, Solar, Exclusive and Formula.



Ventura

Something completely new for your sauna! Ventura's benches, backrests and bench surrounds are made of form-pressed veneer glued in layers. Thanks to the rounded bench finishing it is very pleasant to sit on the benches. Lamps are integrated in the backrests.



Solide

The Solide bench package combines age-old sauna traditions with a fresh and modern design. The sleek and simple design features a rich combination of pale and black colours, which fits in well with the look of new homes. The surfaces can be treated with tinted sauna finish or wax or left untreated to emphasise their pale spruce colour. The bench options include a continuous bench and single sauna seats that are easy to move. The benches are tailored to the dimensions of the sauna.



Scala

Harvia Scala is a different and straightforward bench solution for middle-sized or large saunas. The lower bench spanning from wall to wall and the streamlined upper bench give the sauna a modern look. Instead of fixed upper benches, Scala is also available with separate benches which can be placed freely on the wide lower bench. The material options are heat-treated aspen and heat-treated pine.



Futura

Wood and metal – a bold combination of materials brings a message of the future saunas. The steel strip embedded in the front of the bench and the slim battening used on the benches give the Futura sauna interior a modern look. Choose the material of the benches from abachi, aspen, alder or heat-treated aspen. The backrests and bench surrounds are made of the same material with the benches. Lamps are integrated in the backrests.



Solar

A new type of design. An interesting rhythm of colour and lines. If you want your sauna to be really memorable, Solar is for you. You can choose from abachi, aspen, alder or heat-treated aspen for the bench material, backrests and bench surrounds in Solar.



Exclusive

Bright wood surfaces. Soft, tasteful lines. Furnish your sauna elegantly with Exclusive. The benches, backrests and bench surrounds are made of abachi, aspen or alder according to your taste. The Exclusive style can be enhanced with alder or heat-treated aspen decoration that frames the benches, backrests and the curved corner module.



Formula

Simple lines, fresh forms. Formula is the right interior for you if you appreciate linear design. The basic Variant sauna package includes the Formula interior made of abachi unless you specifically select another wood material or interior design. Formula uses abachi, aspen, alder or heat-treated aspen as the material for the benches, backrests and bench surrounds.

Harmonise the look of your sauna with Harvia glass products

All Harvia sauna glass doors have been specifically designed for sauna use. The glass used in the doors is tempered 8 mm safety glass. The sealant keeps the heat in the sauna room and makes sure that the door closes smoothly. Harvia glass door is easy to install. Glass doors are rectangular shaped.



Choose glass colour from smoky grey, warm bronze, modern clear or stylish satin glass. Doorframe material is either pine, aspen or alder. Door size 8 x 21 and 9 x 21 is recommended for use in household and laundry room doors. Satin door is very suitable for internal door, as its matte surface prevents visibility between the rooms.

The delivery includes unfinished 42 x 92 mm door frame, door frame silicone sealant, safety glass, chrome-plated hinges, magnetic lock and chrome-plated lever handle. Alternatively, you can also choose vertical door handle as an option. On request we deliver specially customized doors.

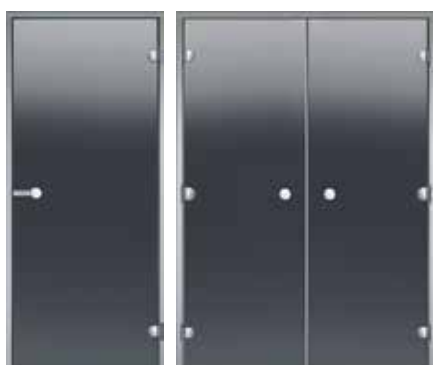

Harvia aluminium frame door

Harvia aluminium frame door is an excellent solution for a steam room or a sauna door. It is designed for conditions where the materials require good humidity resistance. The aluminium frames (40 x 60 mm) are coloured in grey colour. The glass is tempered 8 mm safety glass. Seals keep the heat and steam inside the steam or sauna room. Aluminium frame door is long-lasting and sustainable solution.

The aluminium frame door is installed with hidden screws leaving no screw-heads visible. The end result is elegant and refined. The door handle is a stylish chrome lever handle. The glass colour options are bronze, smoky grey, clear and satin. The Harvia aluminium frame door is available in both single and double glass door. Satin glass is not available for double door.



Legend glass door

Legend glass door appearance is related to the rustic Legend stoves. The frames are black tinted pine, and the handle is made of black painted hardwood. The glass colour alternatives are: clear, bronze, smoky grey and satin. The Legend glass door is available in all standard sizes 7 x 19, 8 x 19, 9 x 19, 8 x 21 and 9 x 21. The Legend door is also available with black painted aluminium frames.



Lockable glass doors

Lockable glass door is suitable for e.g. a dressing room or toilet facilities. The door is available in two sizes: 7 x 21 and 9 x 21. The door frame material is either pine or aluminium. Glass colour is satin. The delivery includes unfinished wooden frame 42 x 92 mm or aluminium frame 40 x 60 mm, silicone sealant attached to the frame, safety glass, chrome-plated hinges and lock case (button and lock are not included in the delivery).

COLOUR ALTERNATIVES FOR GLASS DOORS ▶				
	bronze	Smoky grey	clear	satin
FRAME ALTERNATIVES ▶				
	pine	alder	aspen	black pine
				
	grey aluminium	white aluminium	black aluminium	



Handle options
Knob door handle as a standard,
vertical door handle as an option.

Glass door with opening sidelights

Harvia glass door with sidelights consists of two parts, which together form an openable glass door unit. Choose the glass colour from smoky grey, bronze or clear. The door frame is made of aspen or alder. The glass door with opening sidelights meets the requirements for accessibility in new constructions where the inside dimensions of the frame should be at least 800mm. Thanks to the two-piece door, it can be placed in tight spaces that require a shorter turning radius. The door parts are kept closed using magnetic closure at the top corners.



Harvia double door

The Harvia double door is specially designed for larger Variant and special saunas. It brings a feeling of space to the bathroom and sauna facilities and combines the two spaces into one stylish whole. The glass can be bronze or clear.



Customized glass walls

The customized glass wall in between the bathroom and the sauna creates an image of a larger space. The customized glass wall is tailored according to your own needs. The door frame material is available in aluminium, aspen and alder. Glass colour is clear or satin. Ask for an offer from the factory.



Aluminium strip set

With the aluminium strip set you can finalize the installation of the aluminium frame door. The strip set is available for all standard size glass doors and double glass doors. Black aluminium strip set is designed for the Legend glass doors. The header strip is cut according to the door frame size, the side strips are 2200 mm long and are shortened as needed.

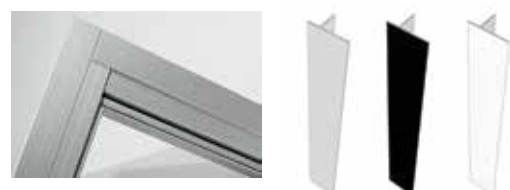

Harvia's panelling and bench material options

In Finland, we really know how to handle wood and build saunas. This expertise has developed over the years, but the basis for everything is still the tradition of sauna expertise and the skill of handling wood that is embedded in the Finnish genes. Many functional and innovative solutions are born from these traditions. All Harvia saunas are manufactured from tough, slowly-grown wood. The trees are felled in accordance with strict EU environmental standards.

A Harvia sauna can be installed anywhere: in indoor spaces, bathrooms, basements or attics. Every Harvia sauna comes with clear instructions for assembly, so you can assemble the sauna yourself or you can use one of the trained, professional assemblers employed by many Harvia dealers. Ask your local dealer for further information.

Panelling alternatives

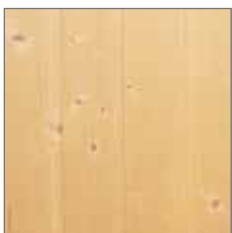

Spruce, STP 95 x 15

Spruce panelling is slowly grown, healthy and tough Finnish softwood with sound knots that enliven the surface. Spruce secretes very little resin, and the wood retains its light colour for many years.



Pine, STP 95 x 15

Pine panelling is made of pure pine board that has a slightly red tinge. Its looks improve with age, and it darkens beautifully as the years pass. Its faint fragrance of pine resin reminds you of fresh pine forests.



STP 70 X 15



Aspen, STP 70 x 15

Aspen is a traditional sauna material because of its characteristics. Aspen's light and even colour is long-lasting and creates a fresh atmosphere inside your sauna.



STP 70 X 15



Heat-treated aspen, STP 70 x 15 / STS 120 x 15

Heat-treated aspen preserves its shape well as the years pass. It is the darkest in colour of Harvia panelling material and also has a pleasant scent. You can accentuate the shade of the wood with paraffin oil.



STS 120 X 15





Fuma (Ventura board 600 x 300)

Fuma retains its light colour well and is highly resistant to both heat and moisture fluctuations.



STP 70 X 15

Alder STP 70 x 15 / STS 120 x 15

Alder has a refined shade of red which deepens with age. It is slightly variegated and easy to care.



STS 120 X 15

Bench alternatives



ASPEN



HEAT-TREATED ASPEN



FUMA
(ONLY VENTURA)



UNTREATED SPRUCE
(ONLY SOLIDE)



TRANSPARENT WHITE SPRUCE
(ONLY SOLIDE)



ABACHI

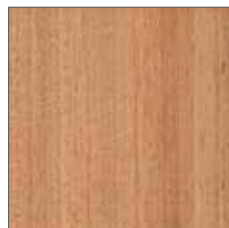

ALDER



HEAT-TREATED PINE
(ONLY SCALA)

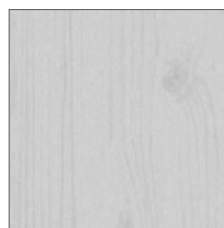

GRAY SPRUCE
(ONLY SOLIDE)

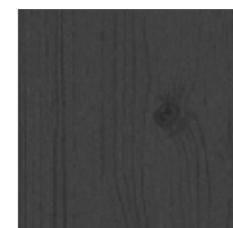

BLACK SPRUCE
(ONLY SOLIDE)

Sauna heaters

Pioneers in technology and design.

A stylish and high-quality Harvia heater is the heart of your sauna. Harvia's popular heaters have always been pioneers in their product group: elegant, durable and economic. The versatile product range and the heaters' ease of use are proof of high-quality design.

Some Harvia heaters are controlled by a separate control unit. More detailed information about Harvia sauna heaters is available in the brochures for Harvia electric heaters and woodburning products and also at www.harviasauna.com.

Heaters for private saunas



COMPACT
Output: 2,0–3,0 kW
Sauna room: 1,2–4 m³



VEGA COMPACT
Output: 2,3–3,5 kW
Sauna room: 1,3–4,5 m³



DELTA, DELTA EE
Output: 2,3–3,6 kW
Sauna room: 1,3–4,5 m³



DELTA COMBI
Output: 2,9 kW
Sauna room: 1,5–4 m³



TOPCLASS
Output: 3,0–8,0 kW
Sauna room: 2–12 m³



MODERNA
Output: 4,5–8,0 kW
Sauna room: 3–12 m³



SOUND
Output: 4,5–9,0 kW
Sauna room: 3–14 m³



VEGA
Output: 4,5–9,0 kW
Sauna room: 3–14 m³



CLASSIC ELECTRO
Output: 6,0–8,0 kW
Sauna room: 5–12 m³



FIGARO
Output: 6,8–9,0 kW
Sauna room: 6–14 m³

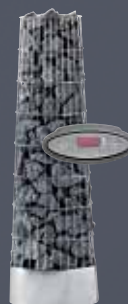

KIVI
Output: 6,9–9,0 kW
Sauna room: 6–14 m³



CILINDRO, CILINDRO H & F
Output: 6,8–9,0 kW
Sauna room: 6–14 m³

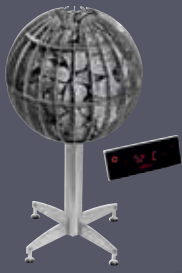

GLOBE
Output: 6,9–10,5 kW
Sauna room: 6–15 m³



FORTE
Output: 4,0–9,0 kW
Sauna room: 5–15 m³



TOPCLASS COMBI
Output: 5,0–9,0 kW
Sauna room: 3–14 m³



STEAMER
Extra equipment
Output: 2,0 kW

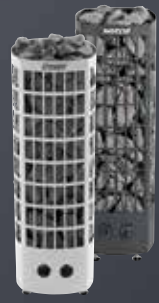

CLASSIC QUATRO
Output: 6,8–9,0 kW
Sauna room: 6–14 m³

Heaters for large private and commercial saunas



SENATOR, SENATOR COMBI
Output: 7,0–10,5 kW
Sauna room: 6–15 m³



HIDDEN HEATER
Output: 6,0–12,0 kW
Sauna room: 6–17 m³



ELEGANCE
Output: 10,5–18,0 kW
Sauna room: 9–35 m³



CLUB, CLUB COMBI
Output: 11,0–15,0 kW
Sauna room: 9–24 m³



LEGEND
Output: 11,0–16,5 kW
Sauna room: 9–35 m³



PROFI
Output: 20,0–33,0 kW
Sauna room: 18–66 m³

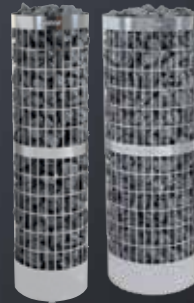

CILINDRO PRO
Output: 16,6–19,8 kW
Sauna room: 15–25 m³ / 20–30 m³



MODULO
Output: 13,6–18 kW
Sauna room: 11–28 m³

Woodburning sauna stoves



LEGEND 240



LEGEND 240 DUO



For steam rooms



PREMIUM



HARVIA 20 PRO



HARVIA 280 CLASSIC TOP

Control units





Harvia colour lights

With Harvia colour light, the atmosphere you desire is in your hands. Colours have a significant effect on the overall health of human beings. Harvia's colour light system consists of a colour light device and a Griffin Colour Light control unit. The system can be installed in medium-sized and large saunas. The colour light device contains four different coloured halogen lamps (green, red, blue and yellow). With the colour light control unit you can set the desired colour light, adjust brightness and speed of the colour light alteration. Colour light is for interior models Exclusive and Solar. Futura colour light matches nicely to Formula and Futura interior models.

Add to the atmosphere of your sauna with lighting

Sauna lights

Choose from two sauna lighting options:

The stylish sauna light is a combination of steel and wood and measures 230 x 180 x 90 mm (width x height x depth). The package includes the lamp and a lampshade. Protection rating IP44, E14 bulb (max. 40 W) not included. The Legend sauna light is coloured black, giving it a consistent look with the rustic Legend stoves.



LED strip

Indirect lighting based on LED strips is the perfect way to add to the warm atmosphere of your sauna. The LED strips can be easily integrated into sauna benches, for example to the front surfaces of the backrest or the upper benches. The LED strip are always tailored based on the benches. The maximum installation height of the LED strips is 1,600 mm. The delivery includes the LED strips, connection cables to the transformer, a terminal strip and a transformer (230 V/12 V). The transformer must be installed in an IP44 rated case and no higher than 500 mm off the floor. A single transformer is enough for 10 m of LED strips.



Illuminated safety railing

The protective railings are available with LED lights: the light enhances the heater beautifully and creates a pleasant atmosphere in the sauna. Stylish protective railings improve the safety of sauna goers. They are made of four wooden arches attached to each other and the sauna heater with stainless steel fixtures. The wood material used is heat-treated aspen.



Illuminated embedding flange

Harvia Cilindro, Cilindro Pro, Globe and Kivi stoves can be embedded into the lowest bench with the help of an optional embedding flange made from stainless steel.

The embedding flange protects from the heat radiation, and thanks to it, the embedding hole is only slightly larger than the sauna heater, making the whole system look better integrated.



Harvia illuminated bucket – the brilliant container for sauna water

The illuminated bucket from Harvia is a modern and stylish way to bring both water and light into the sauna room. The base of the bucket can be mounted on a bench surface or the bucket can be embedded in a bench. The LED light in the base illuminates the bucket evenly and the bucket also illuminates its surroundings – the bucket is made of optical plastic for optimal light dispersion. The bucket can be easily lifted off the base for refill and cleaning. Due to the base being a separate part, the electrical components of the light source are protected from water.



Details in sauna



Door handle

Harvia uses a knob door handle and a magnetic latch in its sauna doors. The magnet keeps the door closed, even if throwing water on the heater causes a pressure wave. The magnetic latch is also designed to be completely safe.



Adjustable legs

Harvia saunas are delivered with adjustable legs fitted into the base frame of the sauna. They prevent moisture from the floor from moving into the lower edges of the sauna walls. Adjustable legs also make it easier to assemble the sauna horizontally if the floor is not even.



Benches

The carpentry skills at Harvia are top quality, and this is especially evident in the bench finishing. The Exclusive, Solar, Futura and Ventura interior's benches are detachable and therefore make cleaning an easy task.



Safe floorboard

Harvia saunas are delivered with safe and hygienic plastic floorboards. Special plastic on the underside prevents the floorboards from sliding on the floor surface. The upper surface has a pleasant graining that prevents slipping. The light boards are easy to clean on both sides and are long lasting. As an alternative, you can also order traditional wooden floorboards made from spruce.



Harvia loudspeakers

Sauna loudspeakers emphasise the sauna experience; pleasant music relaxes the mind. Connect the loudspeakers to your music system to listen to music in your sauna room at the desired volume.

The enclosure rating of the Harvia sauna loudspeakers is IP65, which makes them ideal for humid rooms. Colour white, power 80 W, impedance 4 ohm, frequency response (-10 dB) 60–15,000 Hz, sensitivity 86 dB (1 W/1 m), 6.5" mono speaker, flush mounting depth 50 mm, and diameter 142 mm.



Harvia decorative stone wall

Innovative sauna decoration.

Harvia decorative stone wall helps you to easily create a stylish sauna. It can easily be attached directly onto the sauna panelling. Decorative stone wall is made of quality ceramic stone imitation. The size of the wall element, which is designed for Harvia's ready-made-saunas, is 534 x 1870 mm. The lower part of the decorative stone wall element is made of stylish brushed steel, on which you can mount a heater. Harvia also offers decorative stone wall for higher saunas. The size of this model is 534 x 2040 mm.



534 x 1870 mm



534 x 2040 mm

Sauna products to complement your enjoyment

Harvia's broad range of products offers you everything from high-quality, clean sauna stones to buckets, thermo-hygrometers and sauna aromas.



Floor plans

Claro sauna

Pages 4–5

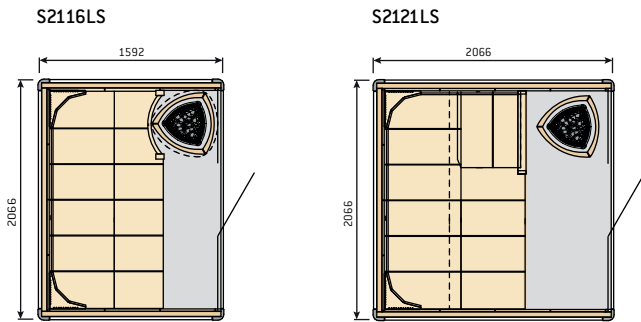

Solide sauna

Pages 6–7

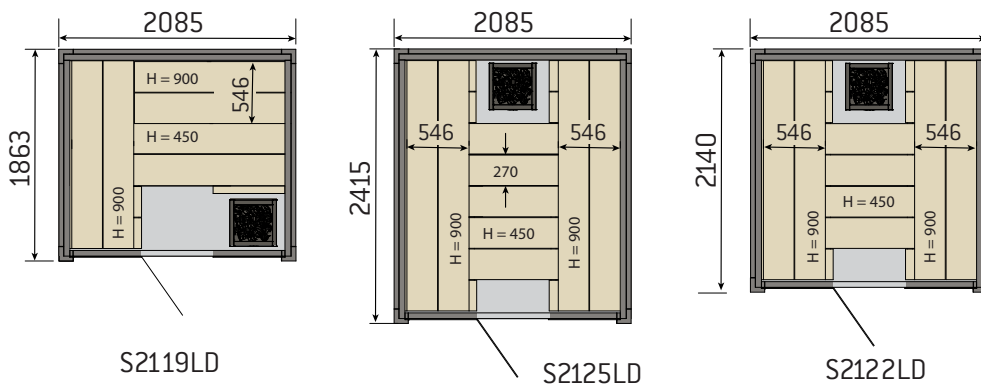

Rubik sauna

Pages 8–9

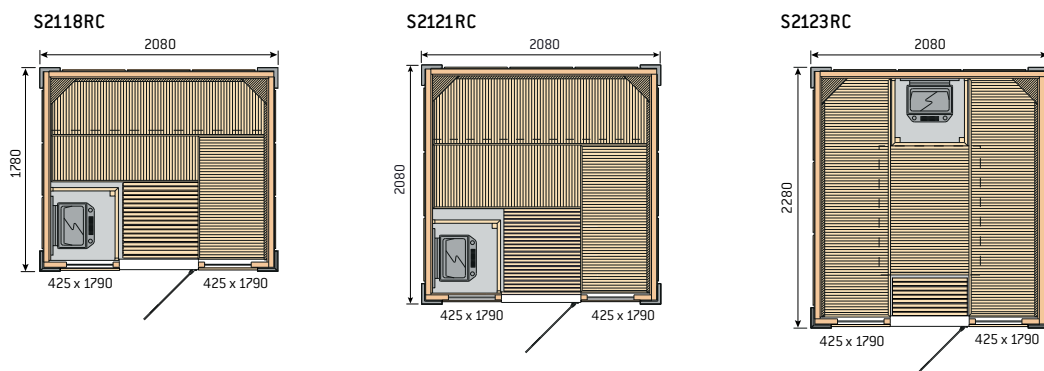

Rondium sauna

Pages 10–11

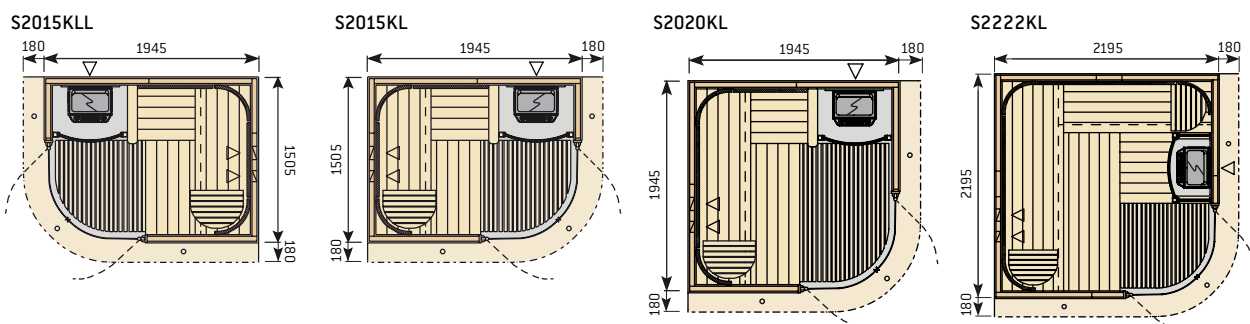

S1010

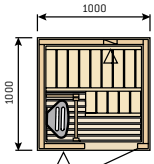

S1212

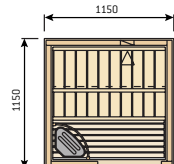

S1215R

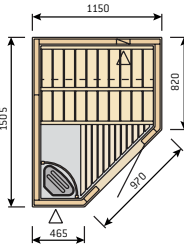

S1215L

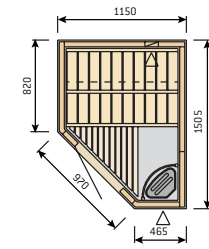

S1515

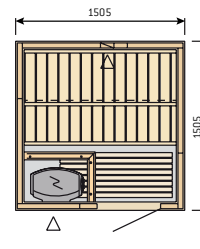

S1515R

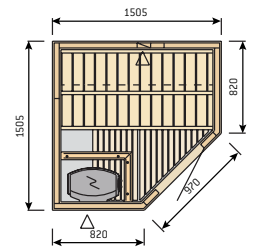

S2015

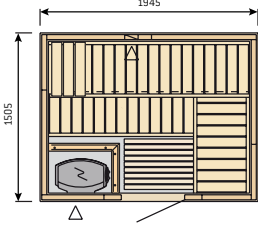

S2015R

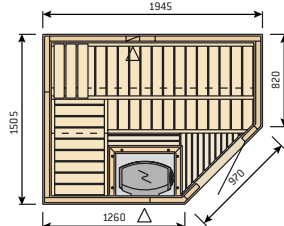

S2015L

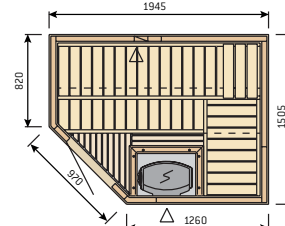

S2020

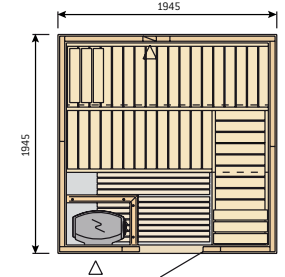

S2020R

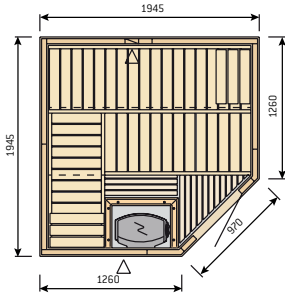

S2220

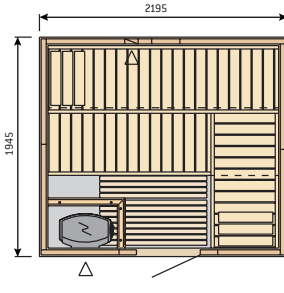

S2220R

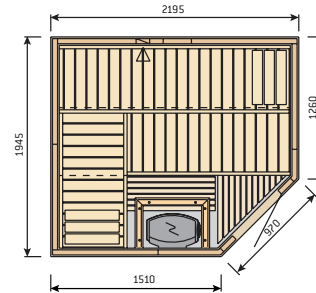

S2220L

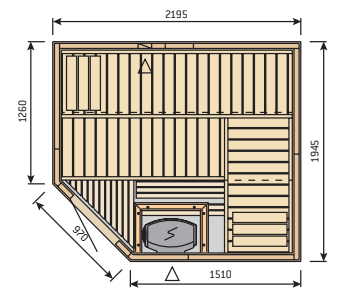

S2220H

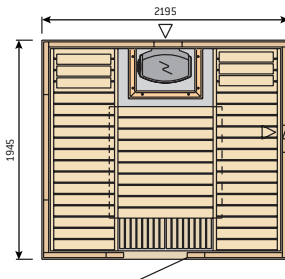

S3020H

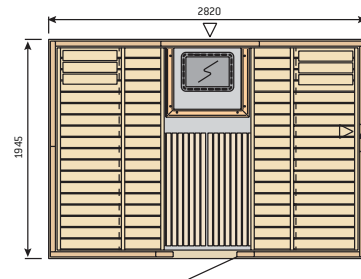

S2222

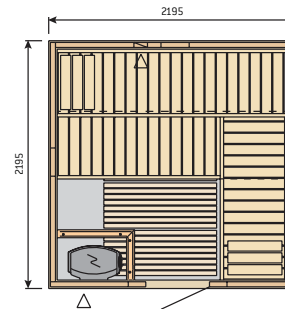

S2222R

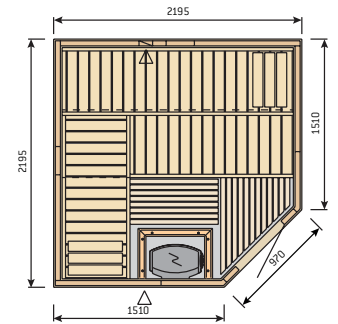

S2520

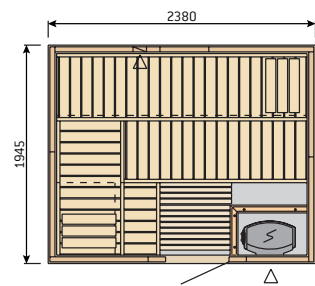

S2520R

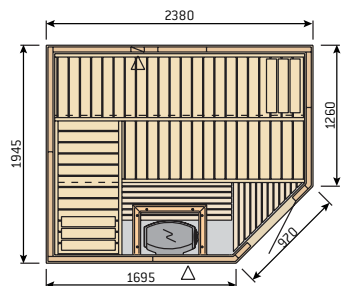

S2520L

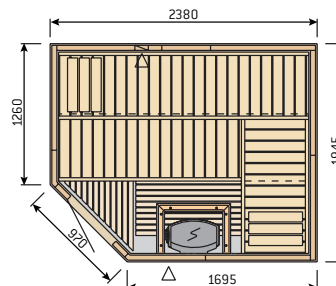

S2522

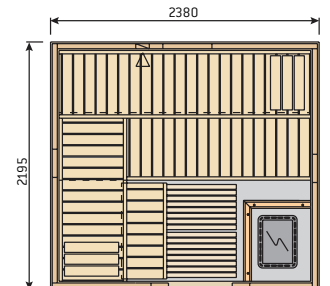

Floor plans

Variant sauna

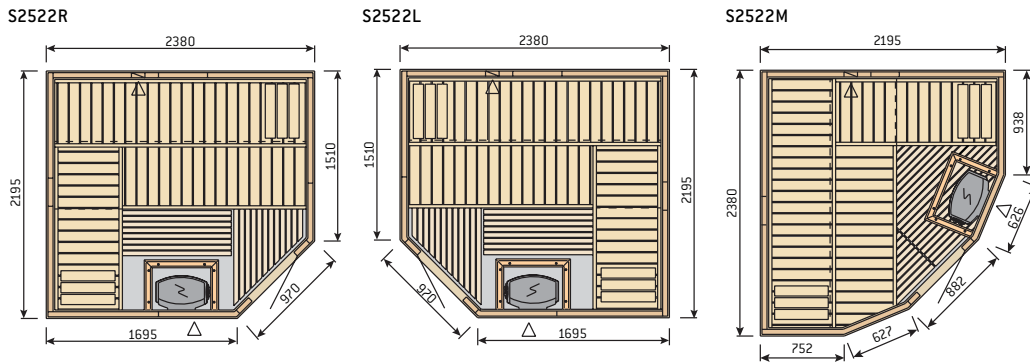

Variant sauna with double door option

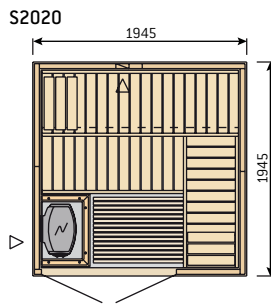

Double doors are available for the models S2020, S2220, S2222, S2520 and S2522.

Bathroom saunas

Sirius

SC1111

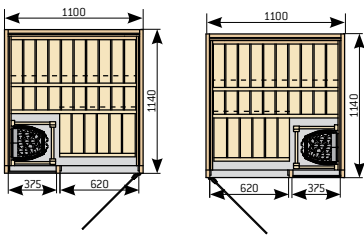

SC1212

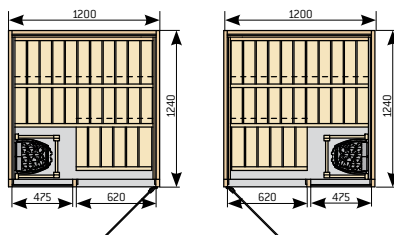

SC1412

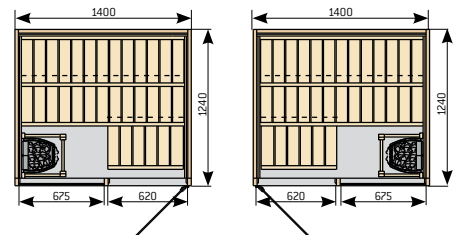

SC1111K

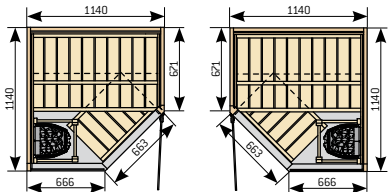

SC1212K

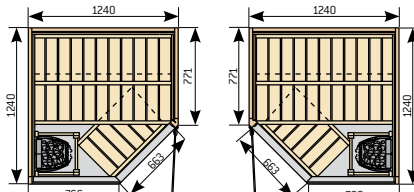

SC1412K

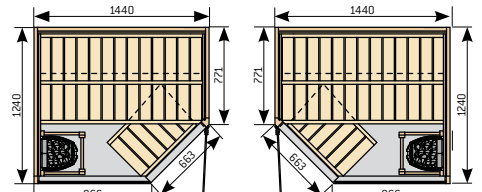

Capella

SC1409

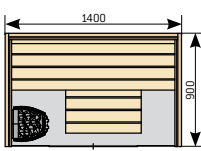

SC1410

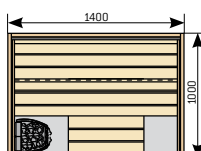

SmartFold

SF1212L

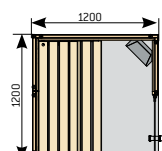

SF1212R

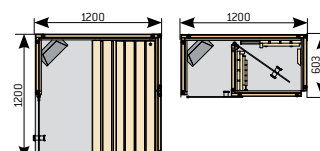

Infrared cabins

Rondium infrared cabin

SG1515KL

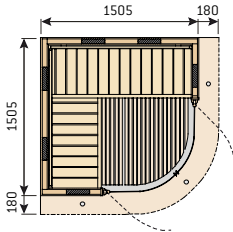

SG2015KL

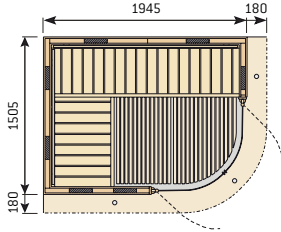

SG2020KL

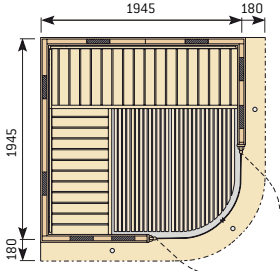

SGC0909BR

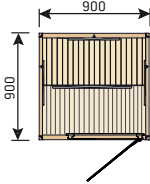

SGC1210BR

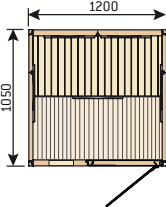

Special saunas and infrared cabins

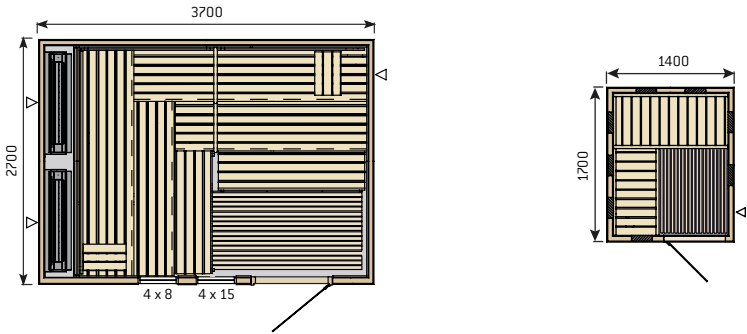

Outdoor sauna

Kuikka

S02200

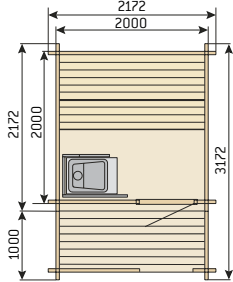

Keitele

S04000

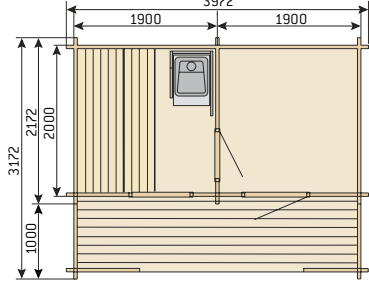

Floor plans

Outdoor sauna

Solide Outdoor 1

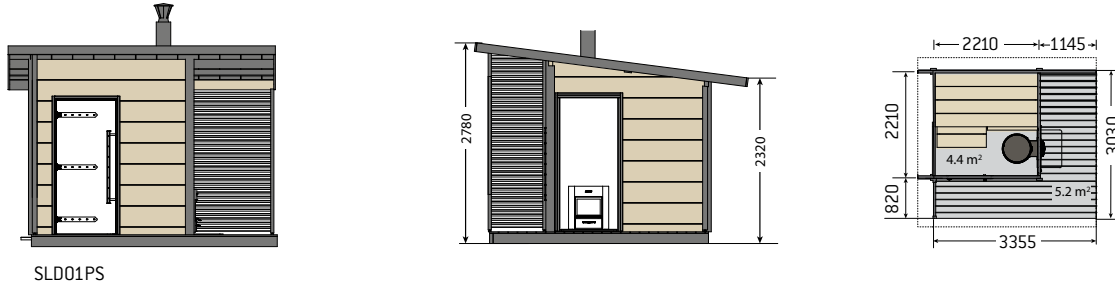

Solide Outdoor 2

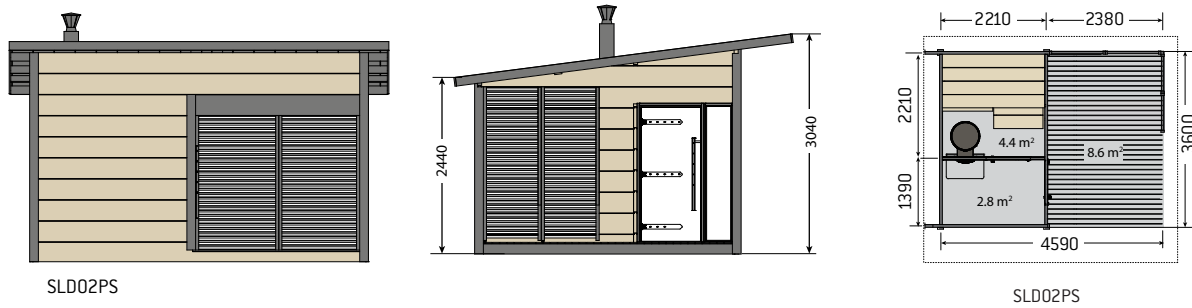

Solide Outdoor 3







Harvia – The many stories of sauna.

The warmth of the sauna attracts us for different reasons. Sauna helps us to relax, to have a good time in good company, or simply to take a moment to ourselves. The comforting warmth of the sauna comes in many forms – in the traditional Finnish wood-heated sauna, the urban city home bathroom sauna, or the modern infrared cabin. We can enjoy sauna in summer as well as winter, in everyday life, or to celebrate special occasions. Sauna can tell many stories.

The Harvia story is unique as well. The company founded in 1950 by Tapani Harvia (1920–1998) has expanded over the decades from a small artist's forge into world's leading sauna heater manufacturer and a forerunner in the sauna business. Behind the success story stands a determined and skillful inventor who forged his business idea and expertise into the shape of a sauna stove. The Harvia companies now employ 300 people. Products are exported globally.

Harvia has developed an extensive range of sauna products for the needs of different bathers. Harvia can provide everything you need in your sauna. Besides sauna heaters, Harvia manufactures saunas, sauna interiors, bathroom saunas, infrared cabins, steam generators, and sauna accessories. The company is firmly focused on product development and the challenges of the future. Harvia wishes to offer the relaxing warmth of the sauna to everyone – just the way they want it.

Local dealer:

HARVIA
Natural well-being.

Contact information:

Harvia Ltd., P.O. Box 12, FI-40951 Muurame, FINLAND
Tel. +358 207 464 000, Fax +358 207 464 090
harvia@harvia.fi, www.harviasauna.com